

AL0802A (8 CHARACTERS x 2 LINES)

FEATURES

- 5 x 7 DOTS WITH CURSOR
- BUILT-IN CONTROLLER (KS0066 OR EQUIVALENT)
- 3.3 V POWER SUPPLY
- 1/16 DUTY CYCLE
- INTERFACE PARALLEL / SPI / I2C

ELECTRICAL CHARACTERISTICS

ITEM	SYMBOL	CONDITION	MIN.	TYP.	MAX.	UNIT
Supply Voltage	V _{DD-VSS}	-	2.4	3.3	3.6	V
Supply Current	I _{DD}	-	-	50	80	mA
Input Voltage	"HIGH" Level	V _{IH}	0.7V _{DD}	-	V _{DD}	V
	"LOW" Level	V _{IL}	0	-	0.3V _{DD}	V
Output Voltage	"HIGH" Level	V _{OH}	0.7V _{DD}	-	V _{DD}	V
	"LOW" Level	V _{OL}	0	-	0.3V _{DD}	V

MECHANICAL DATA

ITEM	DIMENSIONS	UNIT
Module Size (W x H x T)	58.0 x 32.0 x 9.7	mm
Viewing Area (W x H)	29.81 x 13.5	mm
Character Size (W x H)	2.96 x 5.56	mm
Dot Size (W x H)	0.56 x 0.66	mm
Dot Pitch (W x H)	0.60 x 0.70	mm

INTERFACE PIN CONNECTIONS

NO.	SYMBOL	FUNCTION	NO.	SYMBOL	FUNCTION
1	V _{SS}	Supply Ground	9	DB2	Data Bit 2
2	V _{DD}	Supply Voltage	10	DB3	Data Bit 3
3	NC	No Connector	11	DB4	Data Bit 4
4	RS	Register Select	12	DB5	Data Bit 5
5	R/W	Read/Write	13	DB6	Data Bit 6
6	E	Enable Signal	14	DB7	Data Bit 7
7	DB0	Data Bit 0	15	NC	No Connector
8	DB1	Data Bit 1	16	NC	No Connector

BLOCK DIAGRAM

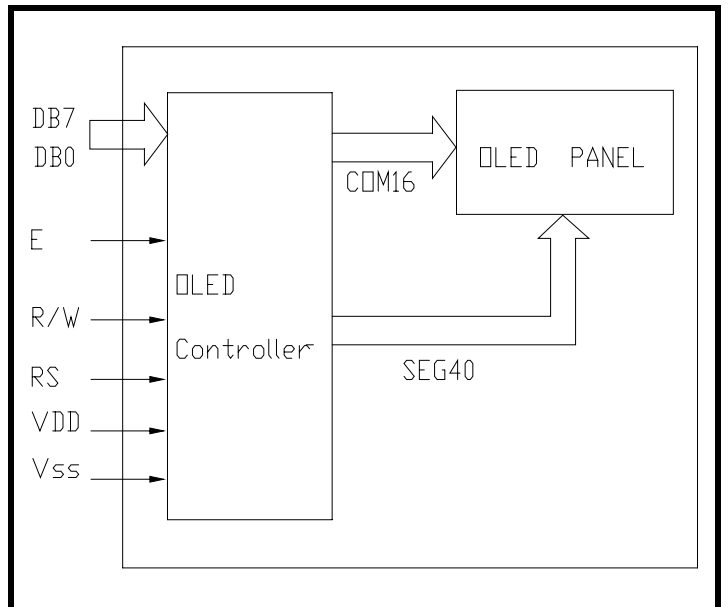

EXTERNAL DIMENSIONS

